

Withings Body

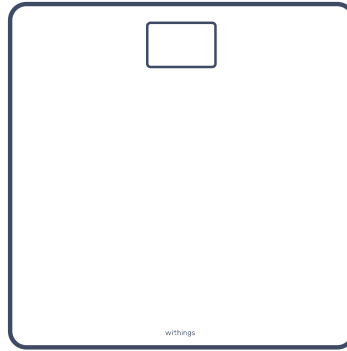

QUICK INSTALLATION GUIDE

クイック インストール ガイド | 빠른 설치 안내서 | 快速安裝指南 | 快速安裝指南

EN | JP | KR | 简 | 繁

THANK YOU FOR CHOOSING THE WITHINGS BODY

Withings BODY をご利用いただき、ありがとうございます

Withings BODY 를 선택해 주셔서 감사합니다

感谢您选择 Withings BODY

感謝你選擇 Withings BODY 電子磅

Box contents

同梱内容 | 포장 내용물 | 包装内容物 | 盒內物品

3

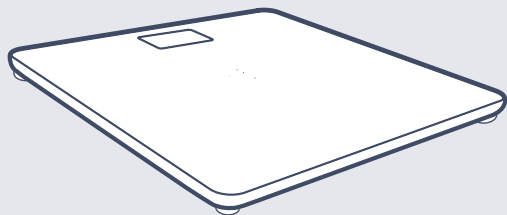

Withings Body

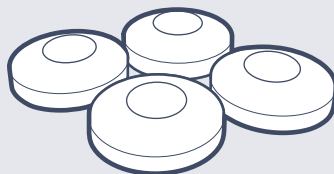

Carpet feet

カーペットフィート | 카펫용 받침부
垫脚 | 地毯支脚

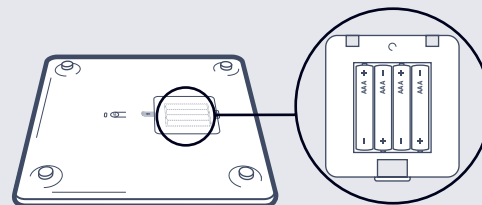

Alkaline cells already installed

アルカリ電池は既に設置されています |
알칼리 전지가 설치되어 있습니다 |
已安装碱性电池 | 已安装碱性电池

Installation of carpet feet (optional)

JP カーペットフィートの設置
KR 카펫용 받침부(옵션) 설치
简 垫脚安装
繁 地毯支脚安装 (可选)

Optional use

JP オプション
KR 옵션 사용
简 可选使用
繁 可选使用

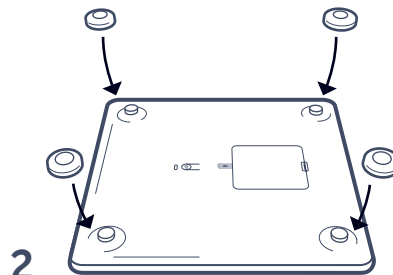
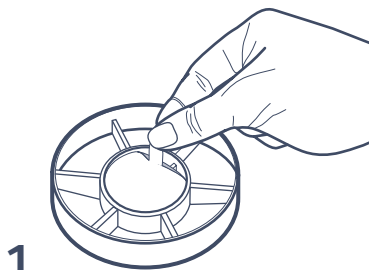

Quick start

クイックスタート | 빠른 시작 | 快速开始 | 快速開始

1

Pull the tab underneath the scale

JP スケール下のタブを引いてください

KR 저울 아랫면에 있는 탭을 당깁니다.

简 拉出体重秤下方的电池插片。

繁 拉動電子磅下方的拉手

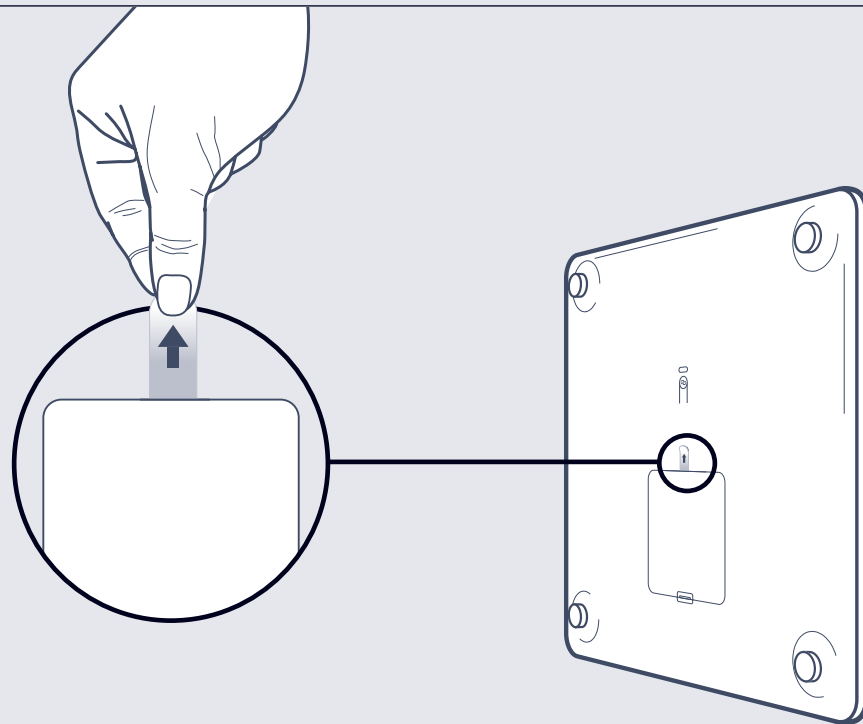

2

Visit go.withings.com to get the app and follow the instructions.

- JP go.withings.com にアクセスし、アプリを取得して、手順に従ってください。
- KR 웹사이트 go.withings.com에서 앱을 다운로드하고 설명서를 참조합니다.
- 简 登陆go.withings.com官网下载应用程序，并按照相关指示进行操作
- 繁 登錄 go.withings.com 獲取應用程式，並按照說明進行操作。



Discover your Withings Body

了解您的Withings Body | 瞭解 Body 電子磅 | Withings Bodyの使い方を学びます | Body 소개

Analyze your Body Composition, and be notified of Rain Forecast for the day, while weighing.

JP 体重を測定している間に身体組成を分析し、その日の降雨予報を表示します。

KR 신체 구성을 분석합니다. 몸무게를 측정하는 동안 그 날의 강우와 일기 예보를 알려줍니다.

简 在称体重的同时分析身体成分、查看当日的天气情况

繁 在稱重的同時，為你分析身體成分，並提供當日的下雨及天氣預報通知。

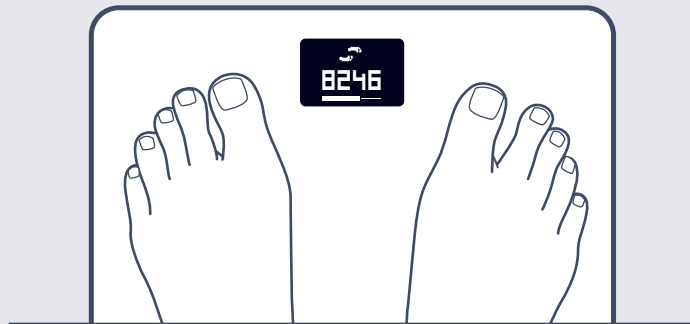

*Only with Wi-Fi connection

*Wi-Fi 接続のみ | *Wi-Fi 연결 전용 | *仅在无线网络环境中
| *僅使用 Wi-Fi 連接



Weight (kg, lb, st lb)

JP 体重(kg)
 KR 몸무게(kg, lb, st lb)
 简 重量 (公斤、磅、英石)
 繁 重量 (kg、lb、st lb)



Number of steps*

JP 歩数 *
 KR 걸음수*
 简 歩数*
 繁 步數*



BMI (Body Mass Index)

JP BMI (ボディマス指数)
 KR BMI(체질량 지수)
 简 BMI (身體質量指數)
 繁 BMI (體重指數)



Weather* (morning | afternoon, °C or °F)

JP 天気 午前 | 午後
 KR 날씨* (오전 | 오후, °C 또는 °F)
 简 天气 早上 | 下午 (摄氏度或华氏度)
 繁 天氣* (上午 | 下午, °C 或 °F)

Customize your screens

スクリーンのカスタム化します | 화면을 원하는 대로 구성 | 自定義您的屏幕 | 自訂你的螢幕

Change the order of the screens and choose what matters most to you.

If you use a Withings watch, activity tracker or track your steps with the Health Mate™ app, activate the Steps screen to know how much you walked the previous day!

JP 画面の順序を変更し、一番重要視している内容の画面を表示させることができます

Withings 活動量計をご使用の場合、または Health Mate™ アプリで歩数をトラッキングされている場合は、歩数画面を起動すると、前日に歩いた歩数を確認できます!

KR 화면 순서를 바꾸고 본인에게 가장 중요한 것을 선택할 수 있습니다.

Withings 워치, 활동 추적기를 사용하거나 Health Mate™ 앱으로 걸음수를 추적한다면 “Steps”(걸음수) 화면에서 어제 얼마나 걸었는지 확인할 수 있습니다.

简 依个人喜好设置各屏幕的显示顺序

如果您已使用Withings手表或计步设备或Withings Health Mate™应用 来记录您的活动,激活“步伐”屏幕,可以查看前一天行走的步数!

繁 更改螢幕次序, 選擇你最關注的事項。

如果你使用 Withings 手錶、活動追蹤器或透過 Health Mate™ 應用程式追蹤步數, 請啟用「步數」螢幕以瞭解你前一天步行的步數!

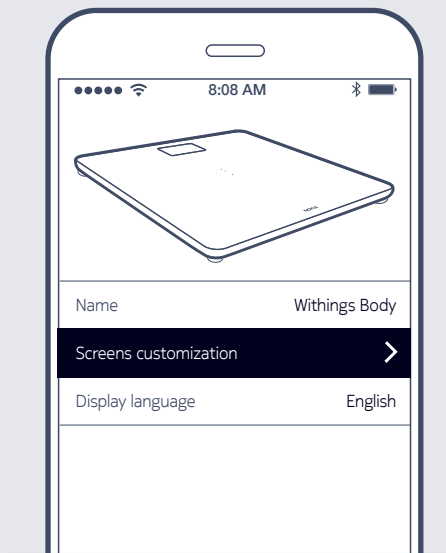

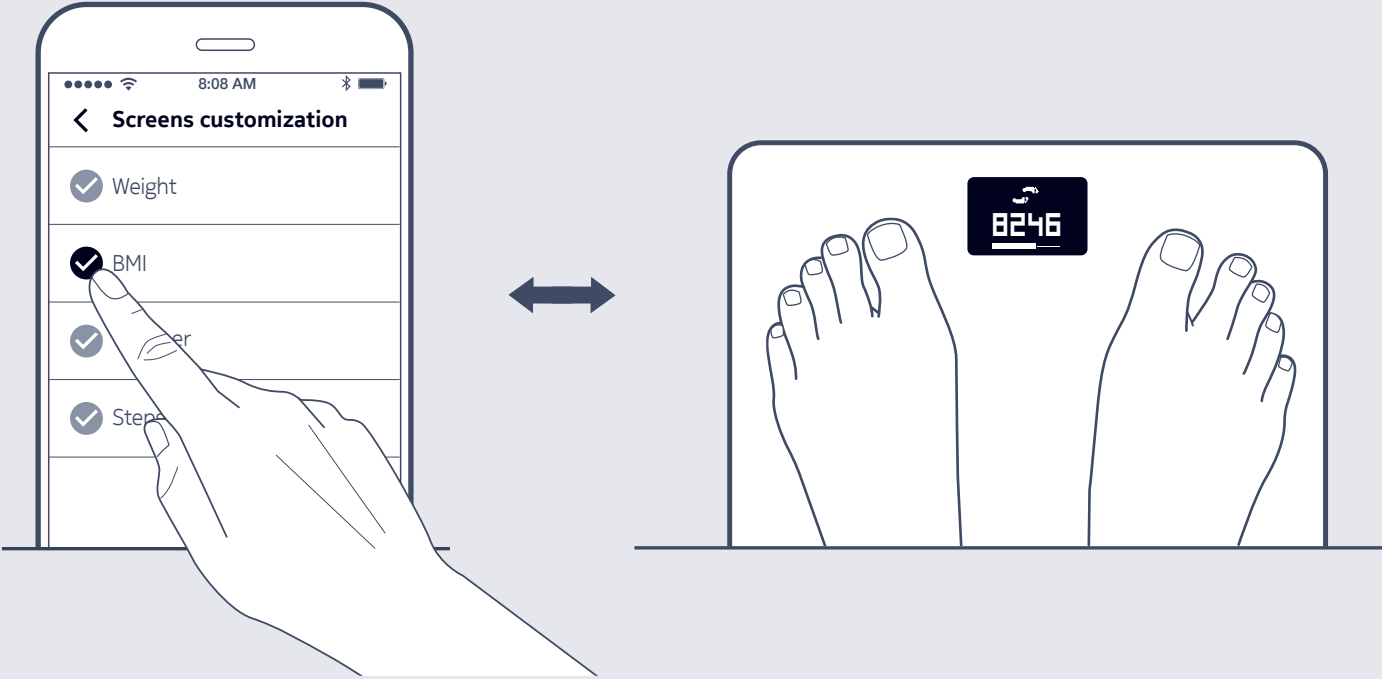

Overview

概略 | 개요 | 包装清单 | 概覽

10

Ⓐ Screen

JP スクリーン
KR 화면
简 显示屏
繁 螢幕

Ⓒ Unit & Pairing button

JP ユニット & ペ어링ボタン
KR 단위 및 연결 버튼
简 蓝牙配对与称重单位选择按钮
繁 單位與配對按鈕

Ⓑ Feet

JP フィート
KR 받침부
简 垫脚
繁 支腳

Ⓓ Battery cover

JP バッテリーケース
KR 배터리 덮개
简 电池盖
繁 電池蓋

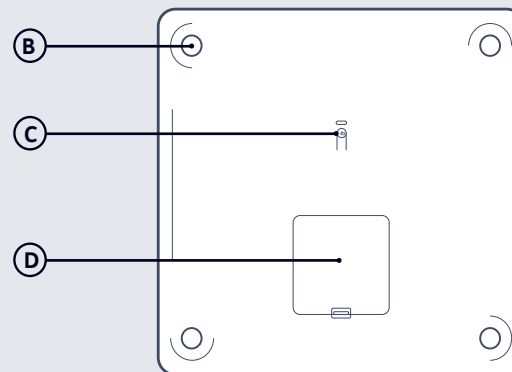
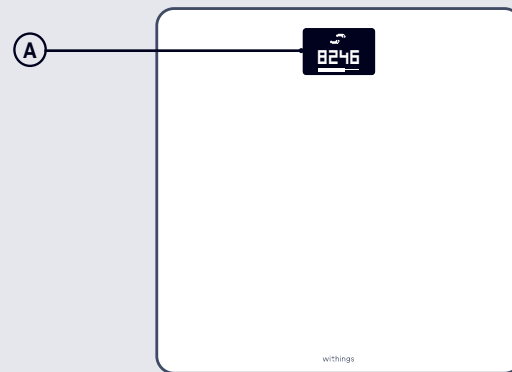

Compliance

简 合规

EN This information applies only to Withings SA Electrical and Electronic Products sold in the People's Republic of China.

Parts	Hazardous Substance					
	Pb	Hg	Cd	Cr6+	PBB	PBDE
Printed Wiring Board Assemblies	x	o	o	o	o	o
Glass parts	o	o	o	o	o	o
Metal parts	o	o	o	o	o	o
Cables & cable assemblies	o	o	o	o	o	o
Plastic and Polymeric parts	o	o	o	o	o	o
Batteries	o	o	o	o	o	o

This table is formulated in accordance with SJ/T 11364

o : Indicates that the concentration of the hazardous substance in all homogeneous materials in the parts is below the relevant threshold of the GB/T 26572 standard.

x : Indicates that the concentration of the hazardous substance of at least one of all homogeneous materials in the parts is above the relevant threshold of the GB/T 26572 standard. The "x" in the above table indicates that some exemptions of EU RoHS are applied in the parts.

The Environment- Friendly Use Period (EFUP) for all enclosed products and their parts are per the symbol shown here, unless otherwise marked. Certain parts may have a different EFUP (for example, battery modules) and so are marked to reflect such. The Environment- Friendly Use Period is valid only when the product is operated under the conditions defined in the product manual. Manufacturing date: 02/20/2017



简 本信息仅适用于Withings科技有限公司在中华人民共和国销售的电器电子产品..

部件名称	有害物质					
	铅	汞	镉	六价铬	多溴联苯	多溴二苯醚
电路模块	x	o	o	o	o	o
玻璃部件	o	o	o	o	o	o
金属部件	o	o	o	o	o	o
电缆及电缆组件	o	o	o	o	o	o
塑料和聚合物部件	o	o	o	o	o	o
电池	o	o	o	o	o	o

本表格依据SJ/T 11364 的规定编制。

o : 表示该有害物质在该部件所有均质材料中的含量均在GB/T 26572 标准规定的限量要求以下。

x : 表示该有害物质至少在该部件的某一均质材料中的含量超出GB/T 26572

标准规定的限量要求。

本表所示的“x”表明使用了欧盟RoHS对于某些有害物质在特定应用中豁免的条款。

此标志也表示了该产品及其部件的环保使用期限. 当某些零部件有不同的环保使用期限时, 会另行标示(例如, 电池单元模块会有另外一个标志贴在其产品上) . 此环保使用期限只适用于产品是在产品手册中所规定的条件下工作.

生产日期: 02/20/2017



Warranty

保修 | 保養服務 | 保証 | 보증

12

EN Withings™ Two (2) Years Limited Warranty - Withings Body

Withings SA, 2 rue Maurice Hartmann, 92130 Issy-les-Moulineaux, (“Withings”) warrants the Withings-branded hardware product (“Withings Product”) against defects in materials and workmanship when used normally in accordance with Withings’ published guidelines for a period of TWO (2) YEARS from the date of original retail purchase by the end-user purchaser («Warranty Period»). Withings’ published guidelines include but are not limited to information contained in technical specifications, safety instructions or quick start guide. Withings does not warrant that the operation of the Withings Product will be uninterrupted or error-free. Withings is not responsible for damage arising from failure to follow instructions relating to the Withings Product’s use.

JP Withings™ の保証は1年間有効です - Withings Body

Withings SA, 2 rue Maurice Hartmann, 92130 Issy-les-Moulineaux, France (以下、「Withings」という)は、Withingsブランドの機器(以下、「Withings製品」という)に関し、材料および製造上の欠陥がある場合、それが Withings 製品に関する公開推奨事項に基づき使用され、エンドユーザーが専門業者より新品の Withings 製品を最初に購入した日から 1 年間の保証(以下、「保証期間」という)を適用します。公開推奨事項には、特に、技術仕様、安全手順、または Withings 製品の取扱説明書が含まれます。Withings は、Withings 製品の作動中断や誤動作についての保証を提供しません。Withingsは、Withings 製品の使用説明書に従わなかったために生じた損害に対する責任は負いません。

KR Withings™ 2년 제한 보증 - Withings Body

Withings SA, (주소: 2 rue Maurice Hartmann, 92130 Issy-les-Moulineaux)(이하 «Withings»라 함)는 Withings 브랜드 하드웨어 제품(이하 «Withings 제품»이라 함)과 관련해 Withings에서 제공한 설명서에 따라 정상적으로 사용했을 때 발생하는 재료와 제작상의 결함에 대해 최종 구매자의 원래 소매 구입일로부터 1년 동안(이하 «보증 기간»이라 함) 보증을 제공합니다. Withings에서 제공한 설명서에는 이에 국한되지는 않지만 기술 명세서, 안전 지침서 또는 빠른 시작 안내서에 나온 정보가 포함됩니다. Withings는 Withings 제품의 작동이 중단되지 않거나 오류가 없다고 보증하지는 않습니다.

簡 Withings™ 的商品保修期为—(2)年 - Withings Body

Withings SA, 2 rue Maurice Hartmann, 92130 Issy-les-Moulineaux, France (“Withings”) 针对 Withings 品牌硬件产品(«Withings 产品»)的材料和工艺缺陷提供保修服务。在用户从专业经销商处购买全新 Withings 产品的初始日期后—(2)年内(“保修期”),如果产品在按照 Withings 产品用户指南建议的条件下使用后出现上述缺陷,我公司将负责产品保修。Withings 用户指南内容包括 Withings 产品的技术规格、安全说明及快速使用手册。Withings 不对 Withings 产品不间断工作或零误差提供保证。若因不遵循 Withings 产品使用说明而造成任损坏,Withings 不承担任何责任。

繁 Withings™ 一年有限保養服務 - Withings Body 電子磅

Withings SA, 2 rue Maurice Hartmann, 92130 Issy-les-Moulineaux (「Withings」) 保證 Withings 品牌的硬件產品 (「Withings 產品」) 從最終用戶購買者的原始零售購買日期 («保養期») 的一 (2) 年內, 在按照 Withings 所公布的指南下正常使用不會出現材料與工藝上的缺陷。Withings 公布的指南包括但不限於技術規格、安全說明或快速入門指南中所包括的訊息。Withings 不保證 Withings 產品的運行不會中斷或無誤。

Notes

Notes



Need help?

需要帮助? | 需要幫忙? | ヘルプ | 도움이 필요하세요?

➔ withings.com/support/body

輸入事業者: SB C&S株式会社
東京都港区東新橋1-9-2 汐留住友ビル 19F
Withings Body WBS06 - 体組成計
ひょう量: 150 kg
目量(最小表示): 200g 測定の下限值5kg
BMI は計算値です。
計量精度: 75kg以下±400g、75kg超±600g

■お問い合わせ先

以下のウェブからWithingsのロゴをクリックしメールフォームでお問い合わせください。

<http://gp.supportweb.jp/>

TEL: 0800-1111-6003

CMIIT ID: 2016DJ2348



This device complies with Part 15 of the FCC Rules. Operation is subject to the following two conditions: (1) This device may not cause harmful interference, and (2) This device must accept any interference received, including interference that may cause undesired operation.

Withings SA hereby declares that the device Withings Body is in conformity with the essential requirements and other relevant requirements of Directive 2014/53/EU. The declaration of conformity can be found at: withings.com/compliance

Mode	Frequency Band (MHz)	Maximum Output Power (dBm)
WLAN	2412-2472	9.87
BT EDR	2400-2483.5	0.85
BT LE	2400-2483.5	9.87

withings

Withings Body | BMI Wi-Fi Scale

© 2021 Withings SA. All rights reserved.